

IPADIPAD

BATTERY PACK FAST CHARGING

N E W 2 0 2 4

UNIVERSAL CHARGER FOR TABLE
WIRELESS CHARGER + USB-A + USB-C

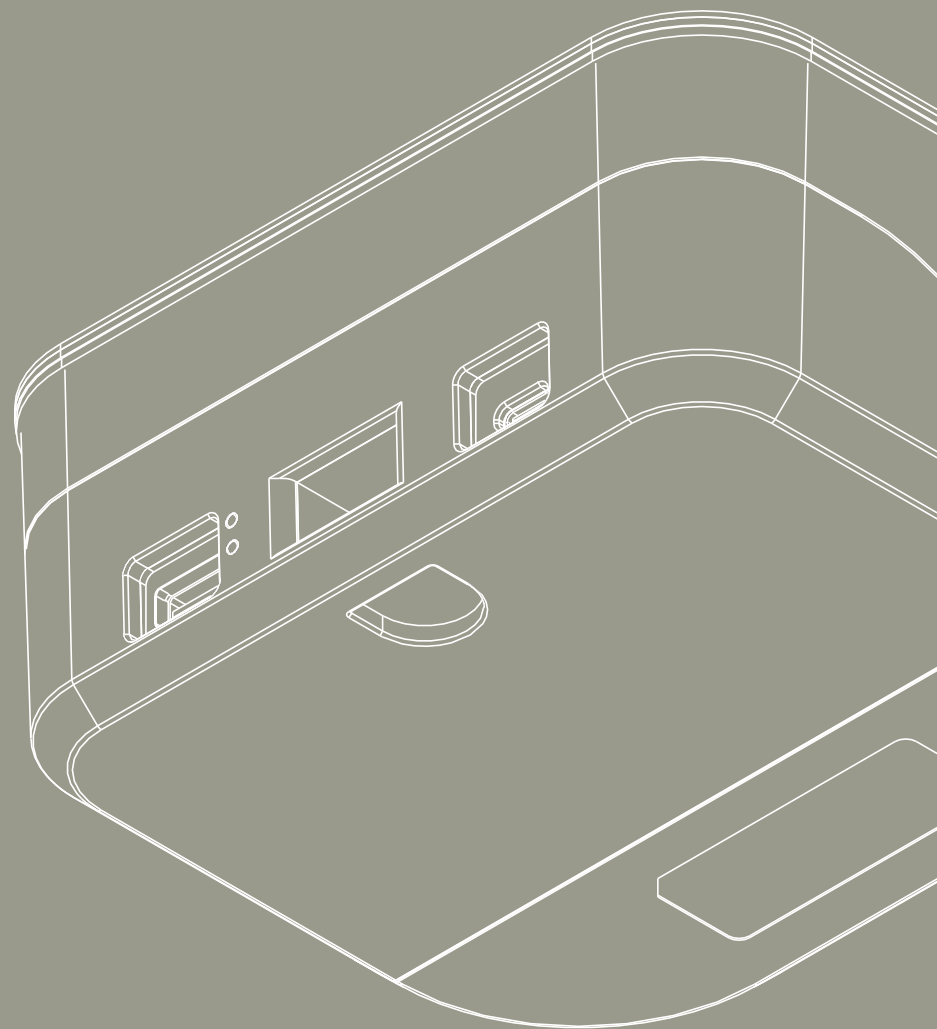



NEED
STAY TO CONNECTED

2/3
customers

want to charge
their smartphone
in Horeca

regularly enter
a Horeca venue
to charge
their smartphone

17%
customers



WHY TO PROVIDE CHARGING SERVICE



Boost
frequentation
of your business

Differentiate
yourself from
the competition



IMPROVE
**CUSTOMER
SATISFACTION**

HERE
**CHARGE
YOUR PHONE**

IPADIPAD

ORIGINAL vs NEW VERSION

BATTERY PACK FAST CHARGING

ORIGINAL

BATTERY PACK

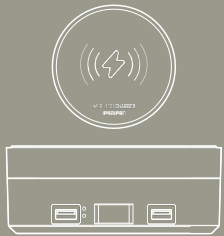

Battery capacity : 55,5Wh



WIRELESS CHARGER



TYPE
A

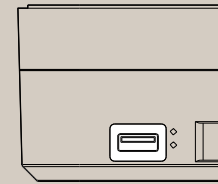

USB SLOT 1



TYPE
A

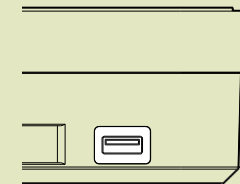

USB SLOT 2

NEW

BATTERY PACK FAST CHARGING



Battery capacity : 74Wh



15W



TYPE
A

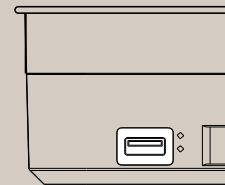

18W



TYPE
C

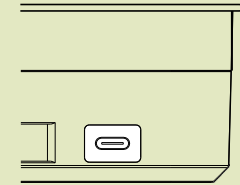

27W

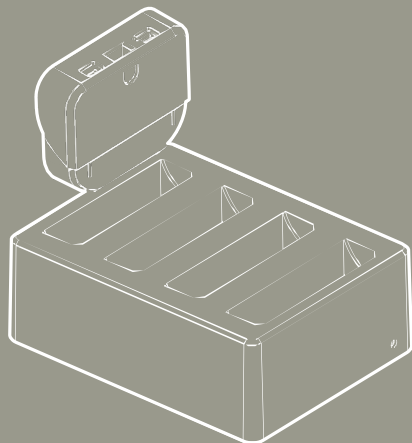

NEW

**CHARGING
TRAY**

IPN-INT-CT



FAST CHARGING
(3h to charge battery)

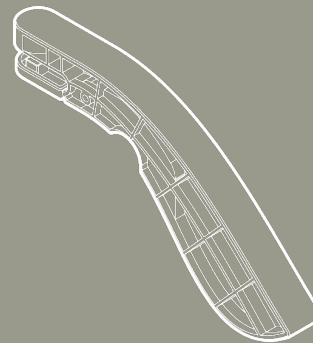

NEW

SECURITY KEY

IPN-INT-KEY



EVEN STRONGER
(Reinforced key)



NEW

**FLAT
ANTENNA**

IPN-ANT-FLT

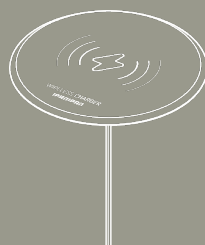

NEW

**ON TOP
ANTENNA**

IPN-ANT-OTP

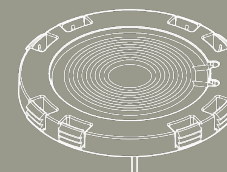

**EMBEDDED
ANTENNA**

IPN-ANT-EMB

KEY POINTS



Wireless charger
FAST CHARGING 15W

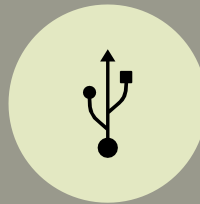

USB-A
FAST CHARGING 18W

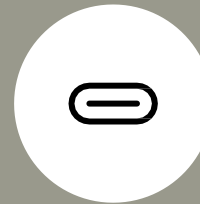

USB-C
FAST CHARGING 27W
(Ideal for charging a laptop)

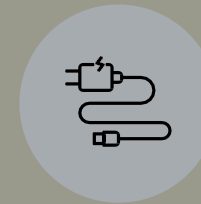

INDIVIDUAL
BATTERY CHARGING
via USB-C slot

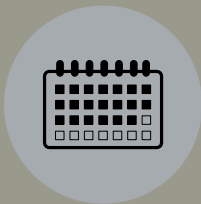

Ultra low stand-by mode
UP TO 20 DAYS

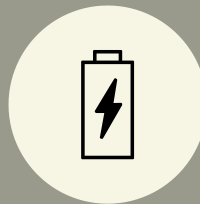

Battery capacity
74Wh
(old version : 55,5 Wh)

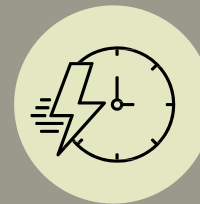

FAST CHARGING TRAY
(3h to charge battery)



REINFORCED KEY
(even stronger)

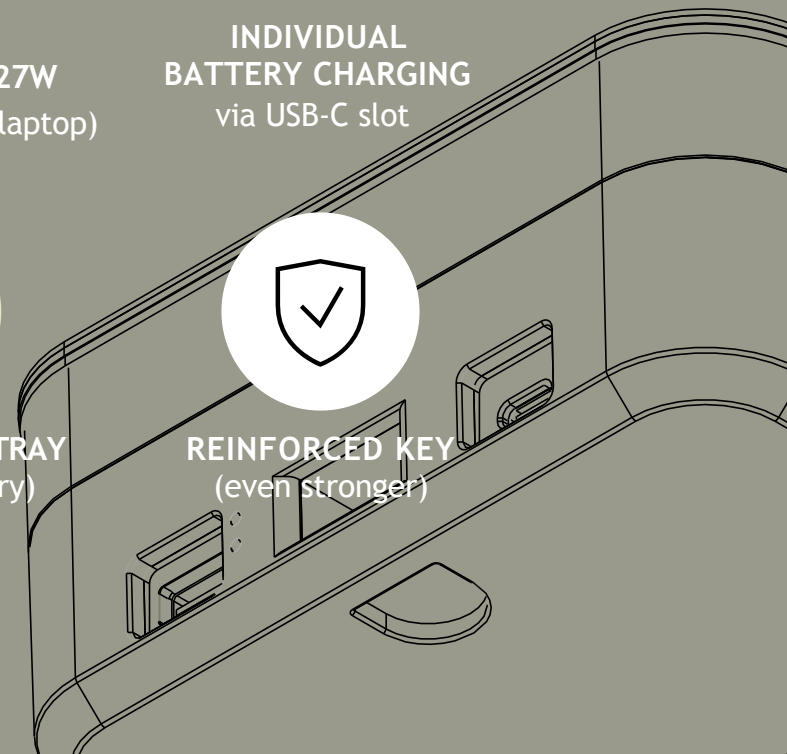

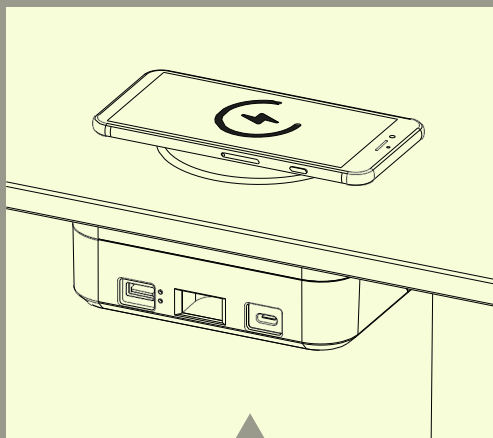

BATTERY PACK
ON TOP

IPN-BPV2/OTP

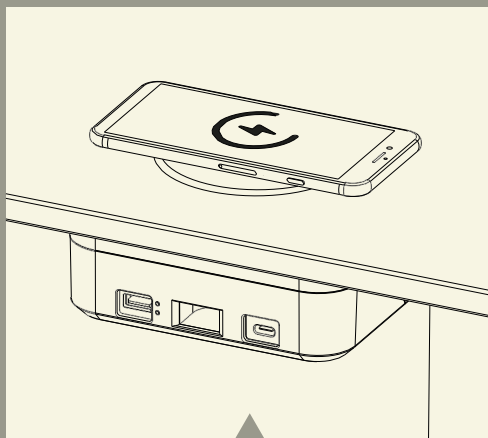

BATTERY PACK
FLAT

IPN-BPV2/FLT

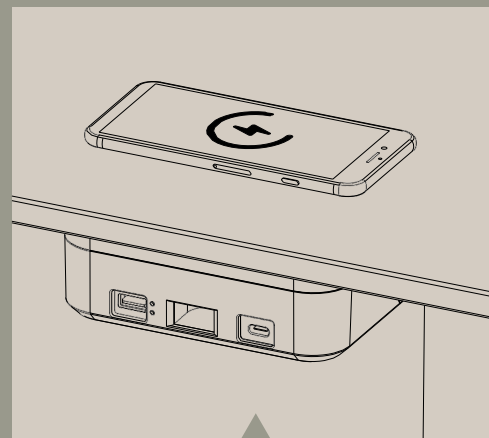

BATTERY PACK
EMBEDDED

IPN-BPV2/EMB

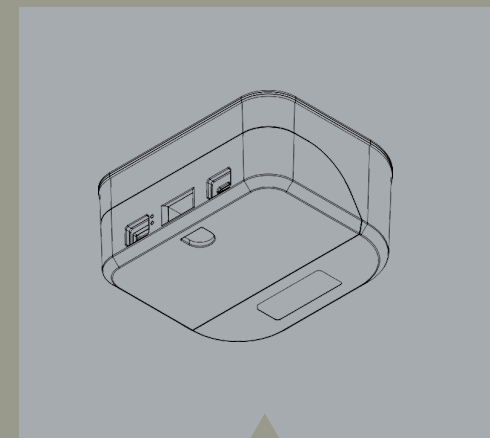

BATTERY PACK
USB

IPN-BPV2/USB

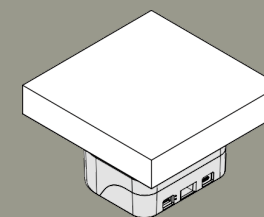
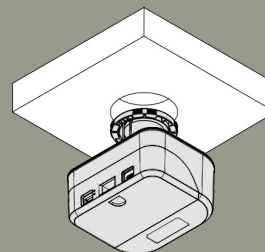
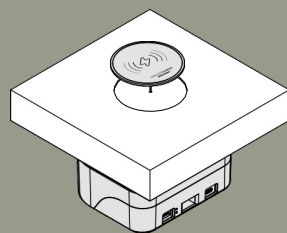
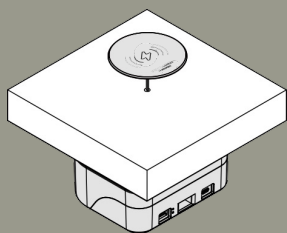

MORE THAN A WIRELESS CHARGER,
A NEW ACCESS POINT FOR YOUR
CUSTOMERS TO YOUR DIGITAL
SERVICES



Access to
the order (via menu)



Access to
payment



Access to the
loyalty program



Access to
special
offers



UNIQUE ANTENNA, UNIQUE SERVICE !

- Enhance Branding awareness
- Be in line with store design and corporate colors
- Attract customers to use the charger, for a better customer's experience

5

CONTINENTS

45

COUNTRIES

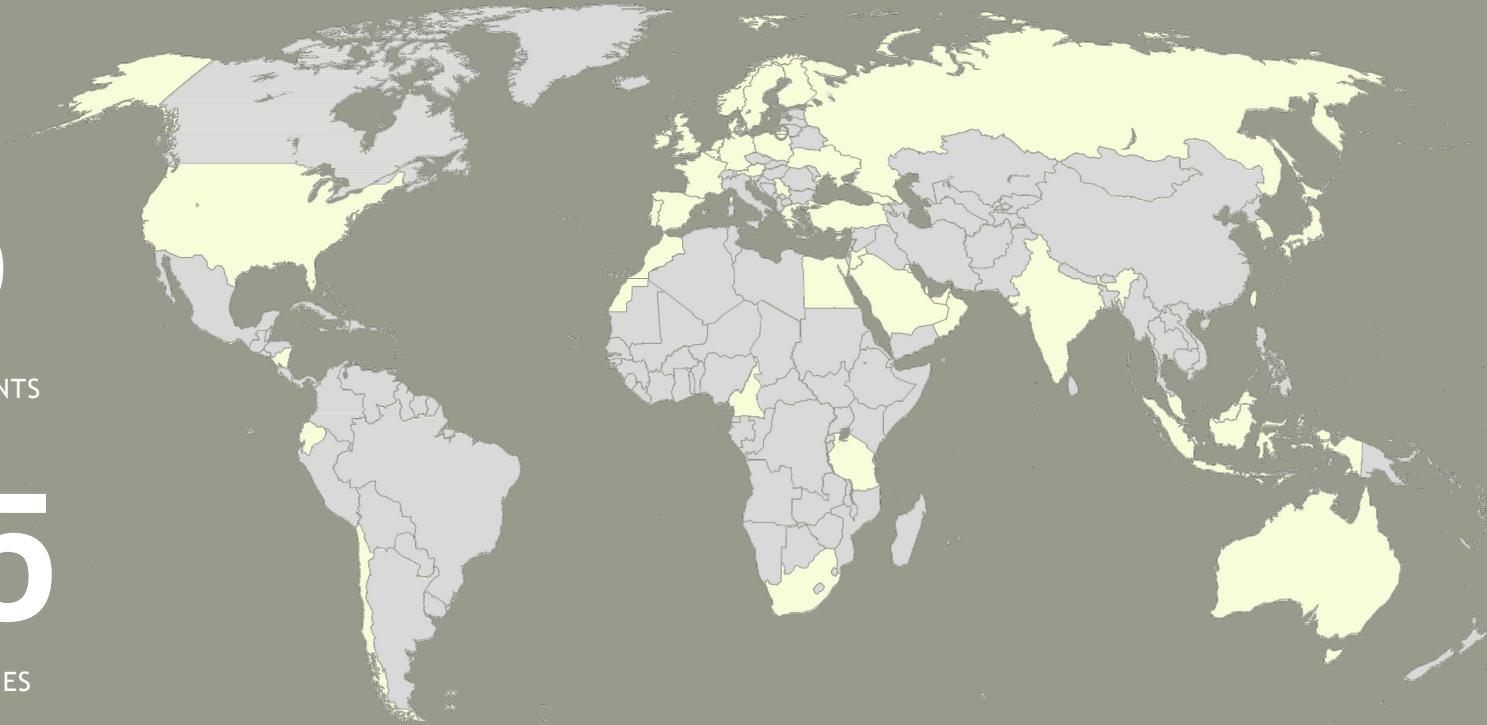

EUROPE

France, Spain, Germany, United Kingdom, Portugal, Andorra, Netherlands, Belgium, Austria, Greece, Cyprus, Serbia, Sweden, Finland, Norway, Denmark, Georgia, Poland, Ukraine, Russia.

AMERICA

USA, Costa Rica, Chile, Ecuador

ASIA

Saudi Arabia, Egypt, Turkey, UAE, Qatar, Kuwait, Oman, Jordan, Bahrain, India, Japan, South Korea, Malaysia, Indonesia, Taiwan,

AFRICA

South Africa, Morocco, Cameroon, Tanzania

OCEANIA

Australia



PowerSurface by Bee-Line B.V.

Nederhoeve 49
3438 LG Nieuwegein
T: 030-268 2957

Whatsapp: 06- 553 840 00
E: info@powersurface.nl

KvK: 57318433
Btw: NL8525.29.351